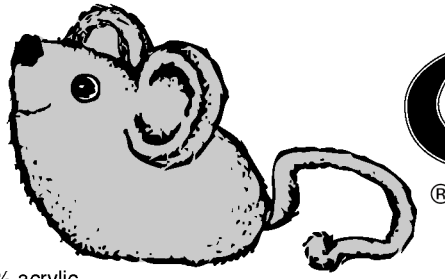

943

SIZE 2 STUFFING

7" SQUEAKY

Haan Crafts, LLC

 506 E. Second Street • PO Box 268
 Otterbein, IN 47970

Fur is 100% acrylic

www.haancrafts.com v3

GENERAL INSTRUCTIONS

1. This kit uses PILE fabric which has two sides, a RIGHT (furry) side and a WRONG (smooth) side. In the illustrations, shaded areas indicate the right side.



RIGHT SIDE



WRONG SIDE

2. Printing is on the WRONG side of the fabric.
3. When sewing, right sides should always be together unless specified otherwise. Stitches should go through the backing and not just the nap.
4. This kit may be sewn by hand or machine. Use 1/4 inch seams for machine sewing. Use 1/8 inch seams for hand sewing.
5. If sewing by machine use a size 14 or 16 needle, and set the stitch length at 10 to 12 stitches per inch.
6. Pin all seams before sewing. If machine sewing, remove the pins as you come to them or be careful not to hit them with the needle while stitching.
7. When the instructions say to stitch to a letter, stitch all the way to the edge by that letter. If reference is made to a specific dot, stitch only to that dot.
8. To secure stitching at the end of a seam, tie a knot if hand stitching or backstitch 4 or 5 stitches if sewing by machine.
9. To sew over a previous seam, pin the seam open if possible to reduce thickness.

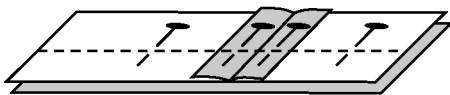

10. When pinning two pieces together, tuck the fur to the inside at the edges to keep it clear from the presser foot and seam gauge.
11. Clean your machine often as excess pile (fur) can build up quickly and cause problems.
12. There may be extra stuffing.
13. If fabric printing is blurry or illegible refer to the layout diagram included in these instructions.

WASHING INSTRUCTIONS

Machine wash and dry. WASH: Warm (120°F), gentle cycle, mild agitation, spin or squeeze water from fabric (DO NOT WRING). DRY: Tumble dry, light load, low heat (100°F) or cool air only.

HAND STITCHING

We suggest an OVERCAST STITCH done as follows: Put the needle in from the bottom about 1/8 inch from the edge and 1/8 inch from the end. Push through to the top. Bring the needle back to the underside 1/8 inch ahead of the previous stitch, and push back up to the top. Continue to advance 1/8 inch with each stitch, pulling the thread tight after each stitch. Be sure each stitch goes through the backing on both pieces of fabric.

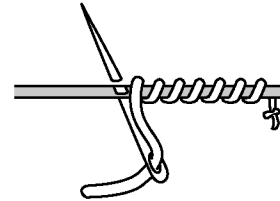
**DETAILED INSTRUCTIONS**

Read each instruction completely before beginning to sew. Check the box below each number to mark that step's completion.

1. Check for missing parts. If any parts are missing write to us at the address above and we will send the part immediately. This kit should contain:
 - printed fur
 - 2 eyes and washers
 - 1 pompom
 - care tag
 - squeaker
 - thread
 2. Cut out all pieces along the solid lines printed on the back of the fabric. Use just the tip of the scissors so that you cut only the knit backing.
- NOTE: Your teacher may prefer that you cut pieces as needed to minimize the chances of losing pieces.
3. Baste (stitch with long, removable stitches) along the broken lines on the LEFT and RIGHT BODIES. This transfers the marks to the right side of the fabric.

LEFT BODY

RIGHT BODY

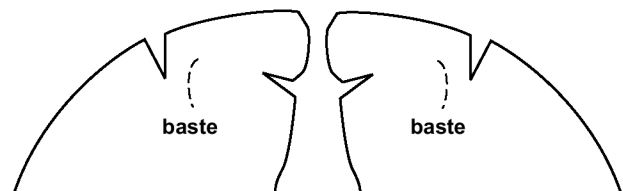

BODY

- 4. Fold and pin the LEFT BODY so right sides are together and B's match.
- Stitch from B to the dot to form a dart, using a 1/4 inch seam.

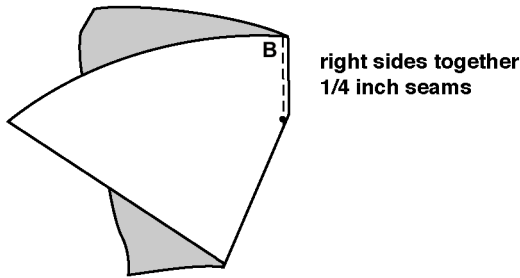

- Repeat with the RIGHT BODY.
- 5. Fold each BODY so that D's match.
- Pin and then stitch from D to the dot on each BODY.

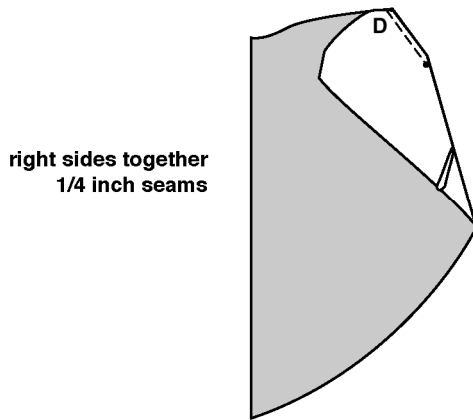

- 6. Pin the LEFT BODY to the RIGHT BODY along the curved edges from A to E, matching at dot C and darts B and D.
- Stitch, pivoting at dot C.

To pivot:
- stop stitching with the needle in the fabric at the dot
- lift the presser foot
- turn the fabric to align the next edge
- lower the presser foot
- continue stitching.

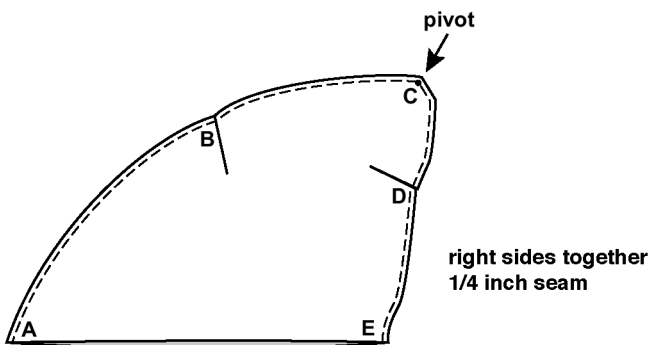

EYES

- 7. Snip at the X's for the eyes on each BODY, being careful not to cut beyond the X.
- From the right side of the fabric insert an eye in each hole.
- Push a washer onto the stem with the concave or flat side facing the eye. Do NOT press on firmly yet.



CARE TAG

- 8. Write your name in the space provided on the care tag.
- Pin the tag to the right side of the BASE at G so the edge that says "Insert in Seam" is even with edge of the fabric.
- Stitch across the end to secure.

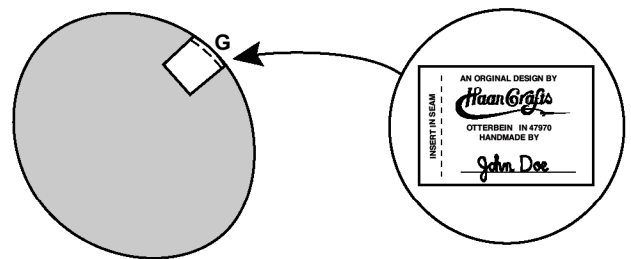

BASE

- 9. Pin the BASE to the BODY, matching the dots to the seams at E and A and matching the lines.
- Stitch around the base, leaving open from F to G.

right sides together
1/4 inch seam

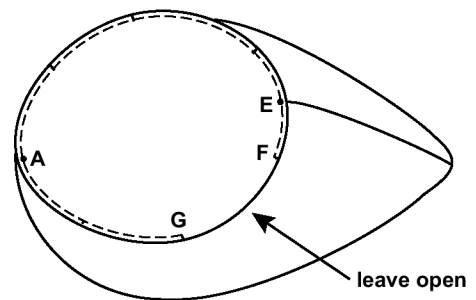

- Turn the mouse right side out.
- Rotate the eyes so the lashes point toward the back of the head.
- Press the washers on firmly.

- 10. Put the squeaker inside the mouse, at the tip of the nose.
- Stuff the mouse through the opening, being careful to stuff evenly.
- Hand stitch the opening closed.

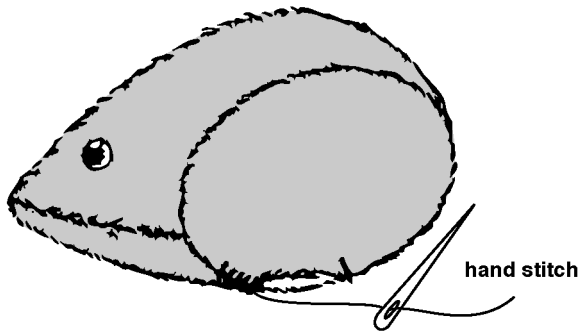

EARS

- 11. Fold and pin each of the four EARS so H's match.
- Stitch from H to the dot on each EAR to form darts.

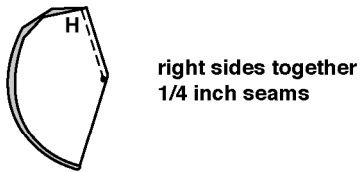

- 12. Pin and stitch two EARS together along the rounded edges.

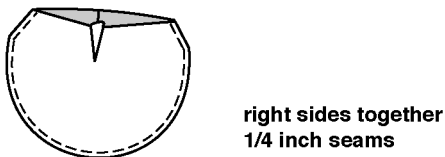

- Repeat with the remaining two EARS.
- Turn the EARS right side out.
- Baste the open edges of one set of EARS together.

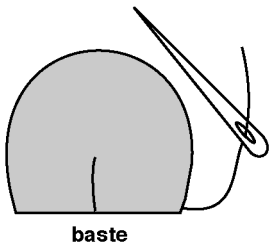

- Repeat with the remaining set of EARS.
- 13. Pin the EARS to the head along the placement lines.

- Hand stitch around the base of both EARS, being sure to catch the fabric backing in the stitches.

**hand
stitch**

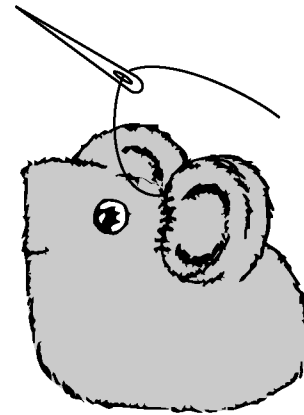

FINISHING

- 14. Hand stitch the pom-pom on the tip of the nose, using several stitches to hold it securely.

**hand
stitch**

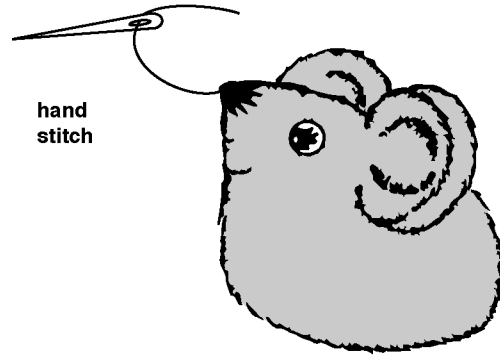

- 15. Trim the printed lines from the TAIL.
- Fold the TAIL in half lengthwise with the RIGHT side out and edges even.
- Hand stitch along the long edges.
- Position the widest end of the TAIL on the mouse at the center back so the stitched edge faces down.
- Stitch all around the base of the TAIL, taking care to stitch through the backing on both layers of fabric.

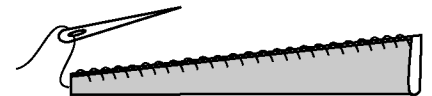

- 16. To make seams almost invisible, run a comb or pin gently along the seamlines to free the nap.

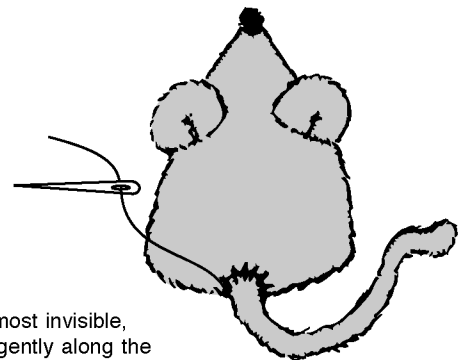

That's it! Congratulations on a job well done!

